

Article number: 20262021

Description: E+G

Indexing plunger GN 817-6-9-G

Measures

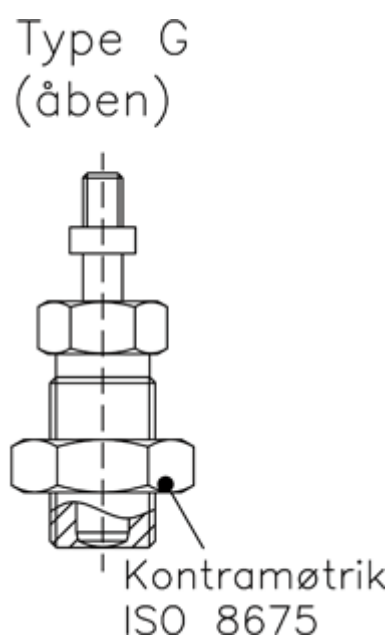
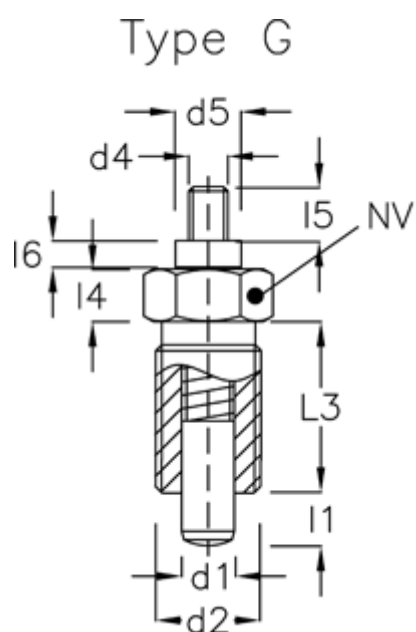

d1 = 6	l6	= 3.5
d2 = M12x1,5	NV	= 14
d4 = M5	Spring pressure N bottom	= 25.0
d5 = 9	Spring pressure N top	= 6.0
l1 = 9		
l3 = 22		
l4 = 6		
l5 = 7.0		